

TOP VIEW

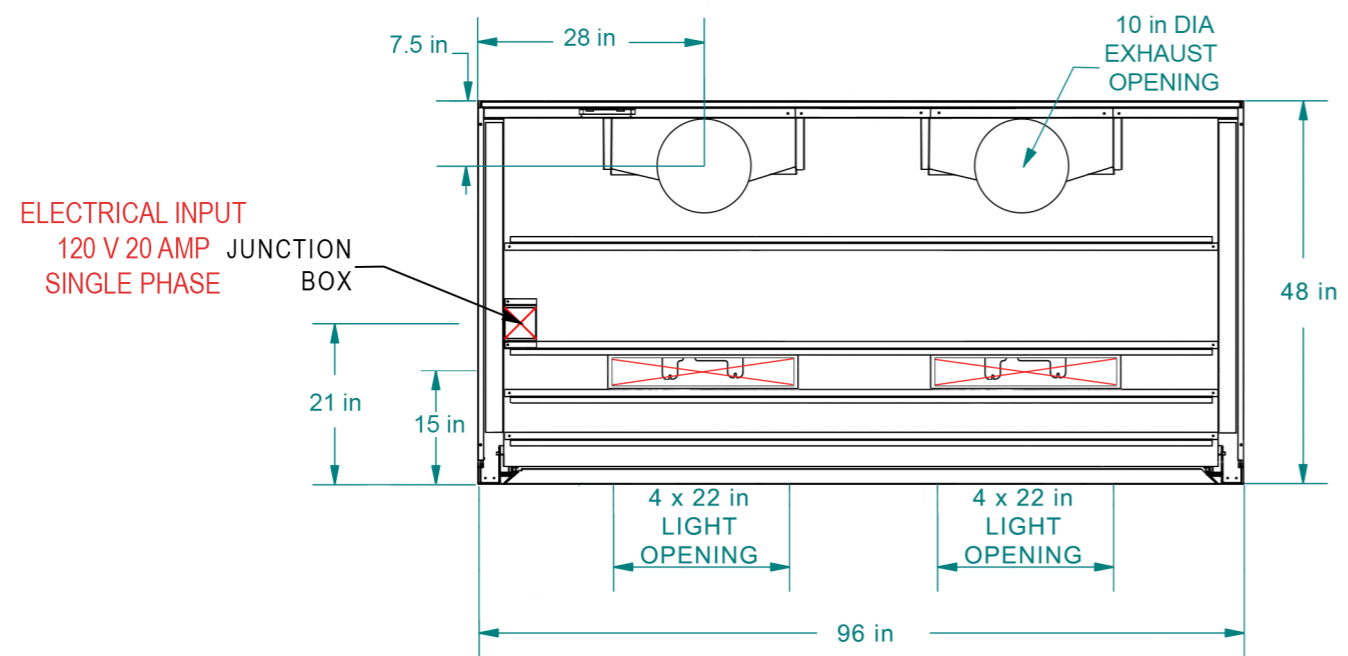

NOT TO SCALE

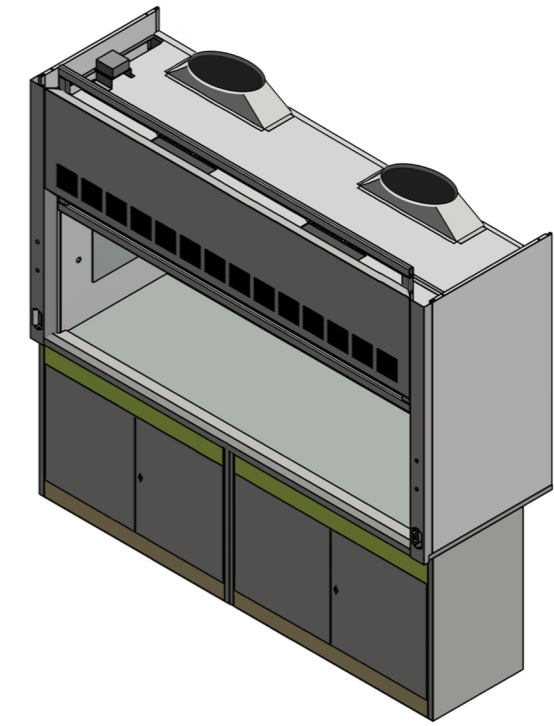

LEFT SIDE VIEW SASH OPEN

FRONT VIEW SASH OPEN

RIGHT SIDE VIEW SASH OPEN

BACK VIEW SASH CLOSED

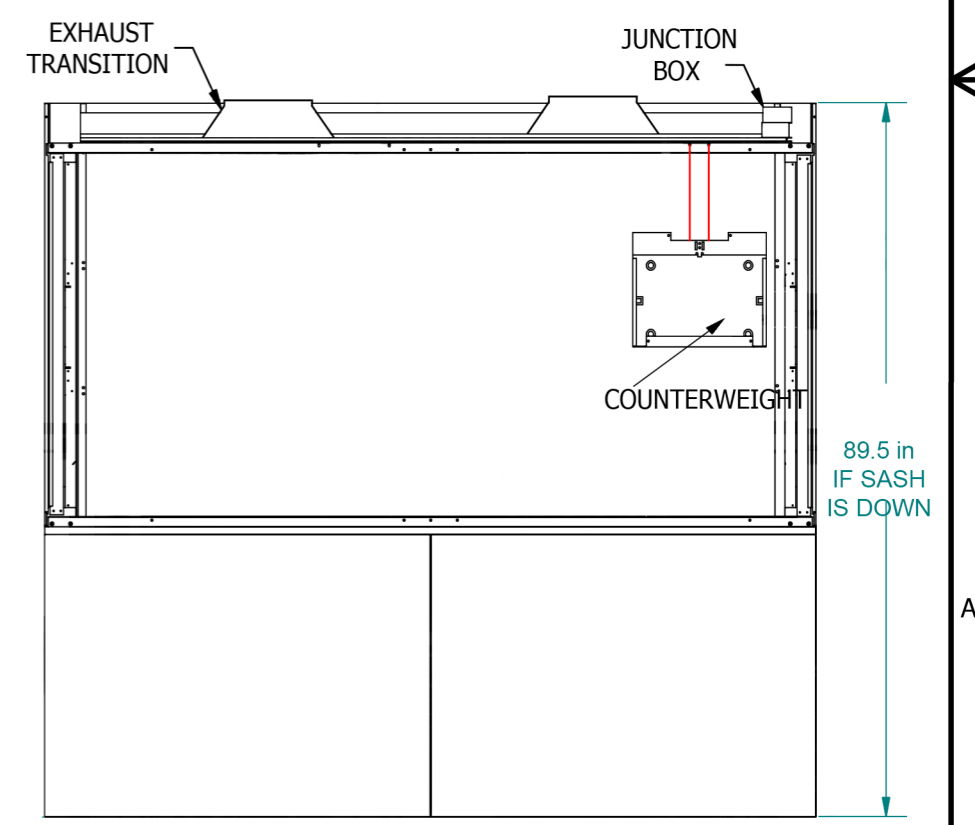
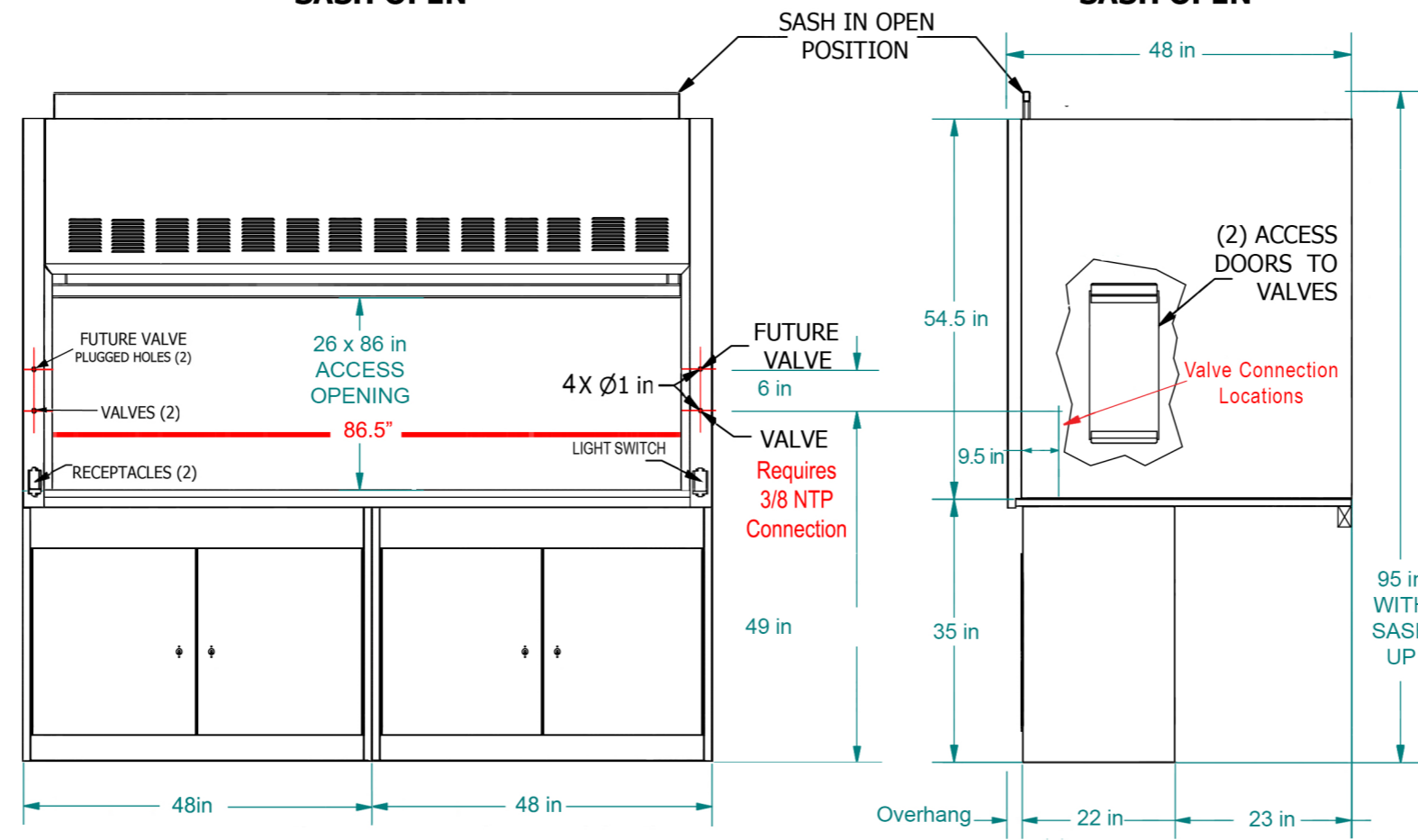
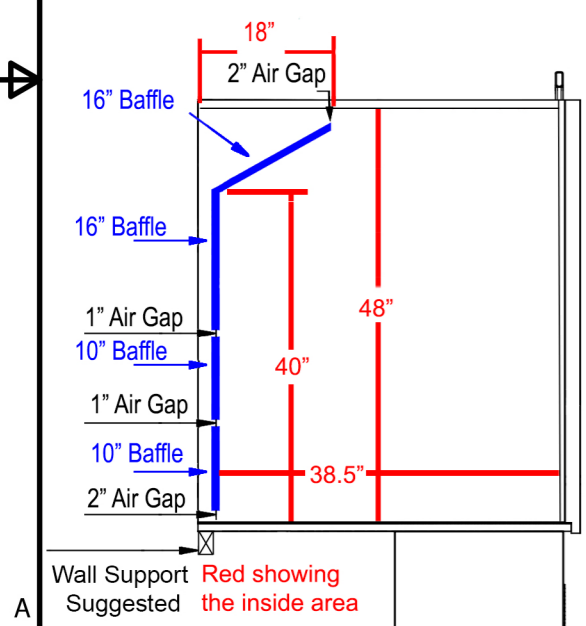

8' x 4' FUME HOOD
FA FISHER AMERICAN CLASSIFIED **UL**
(815)-670-6400