

TOP VIEW

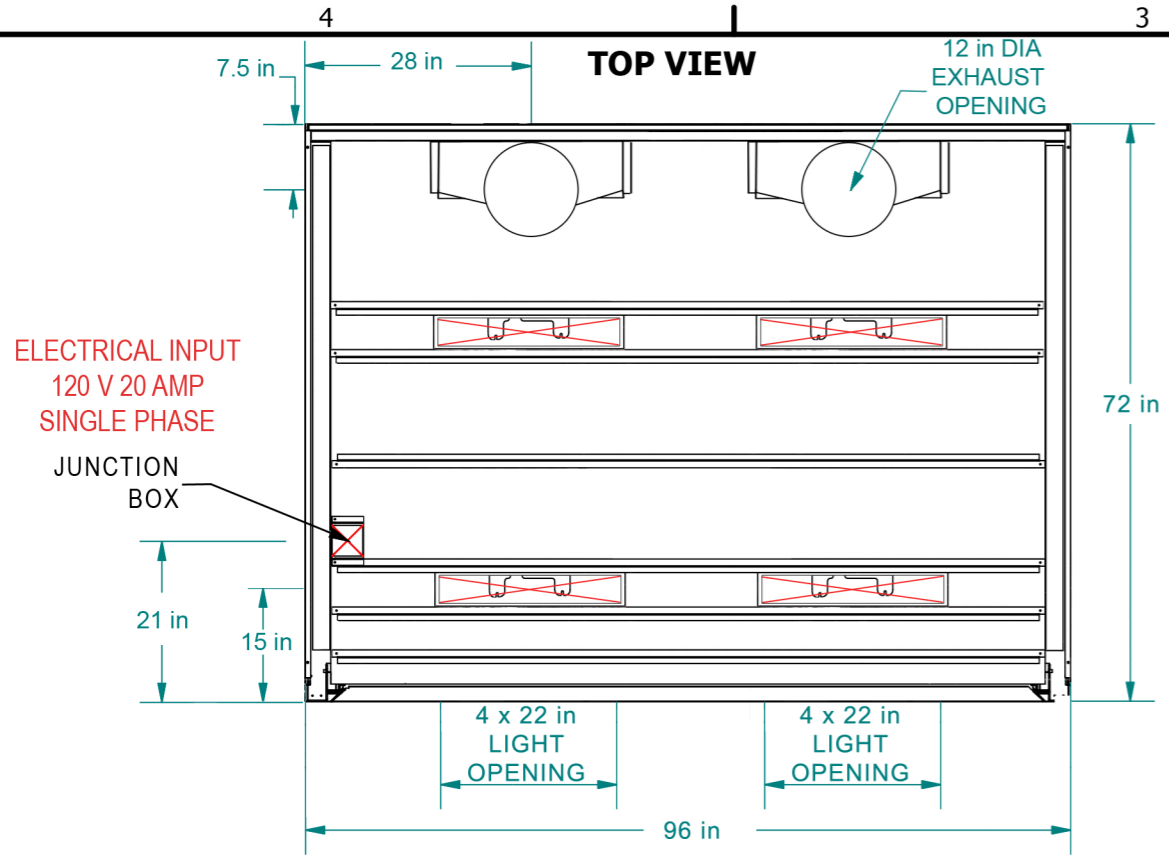

NOT TO SCALE

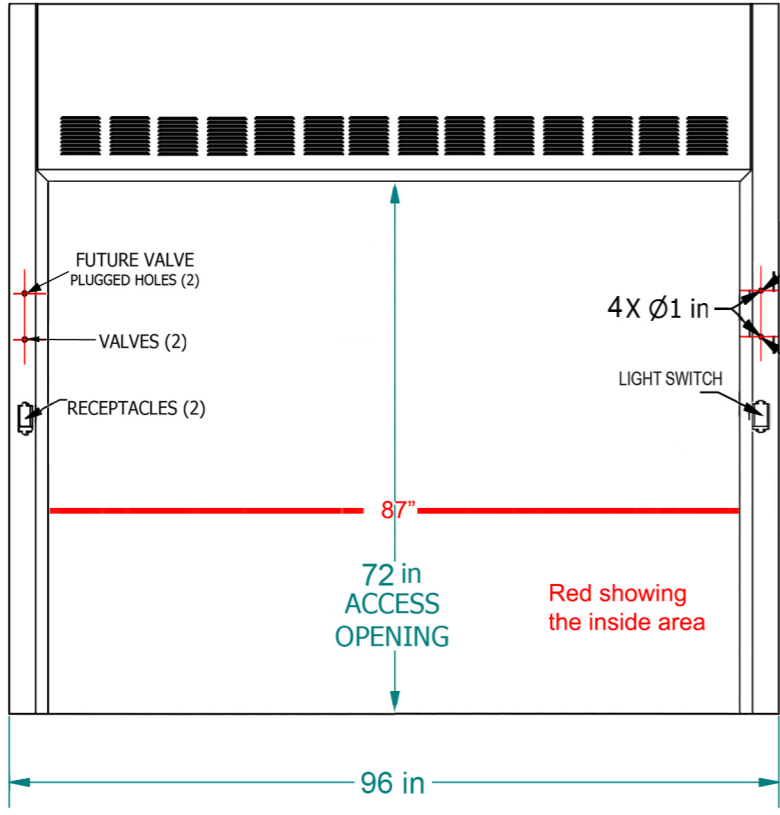
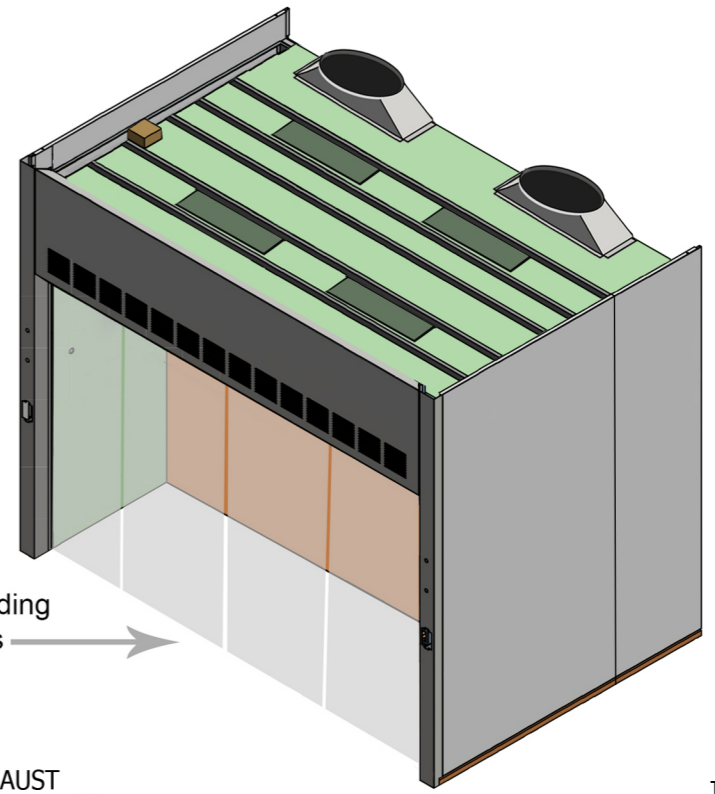

FRONT VIEW SASH OPEN

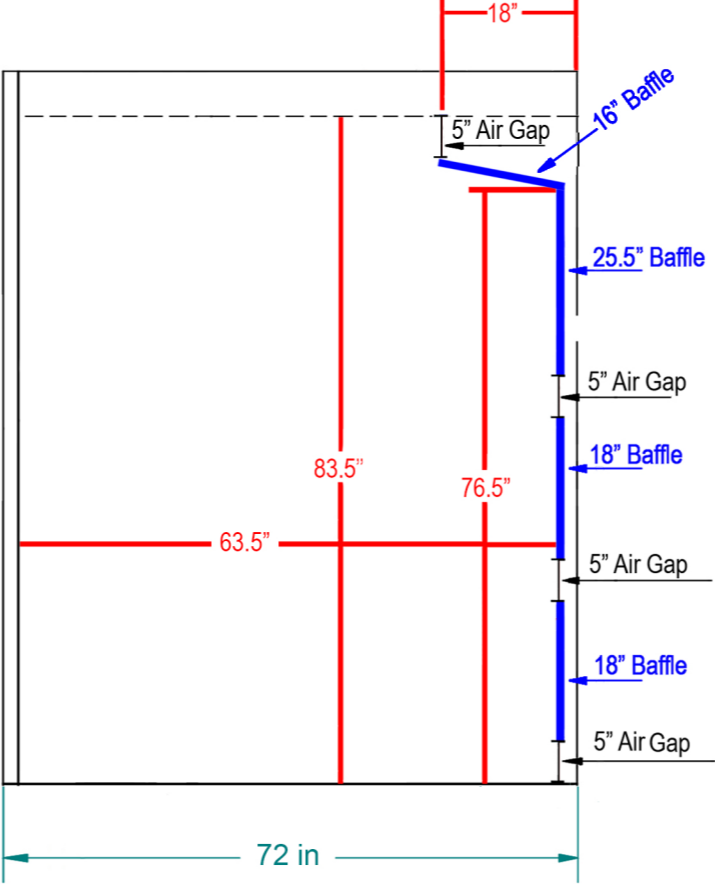

RIGHT SIDE VIEW SASH OPEN

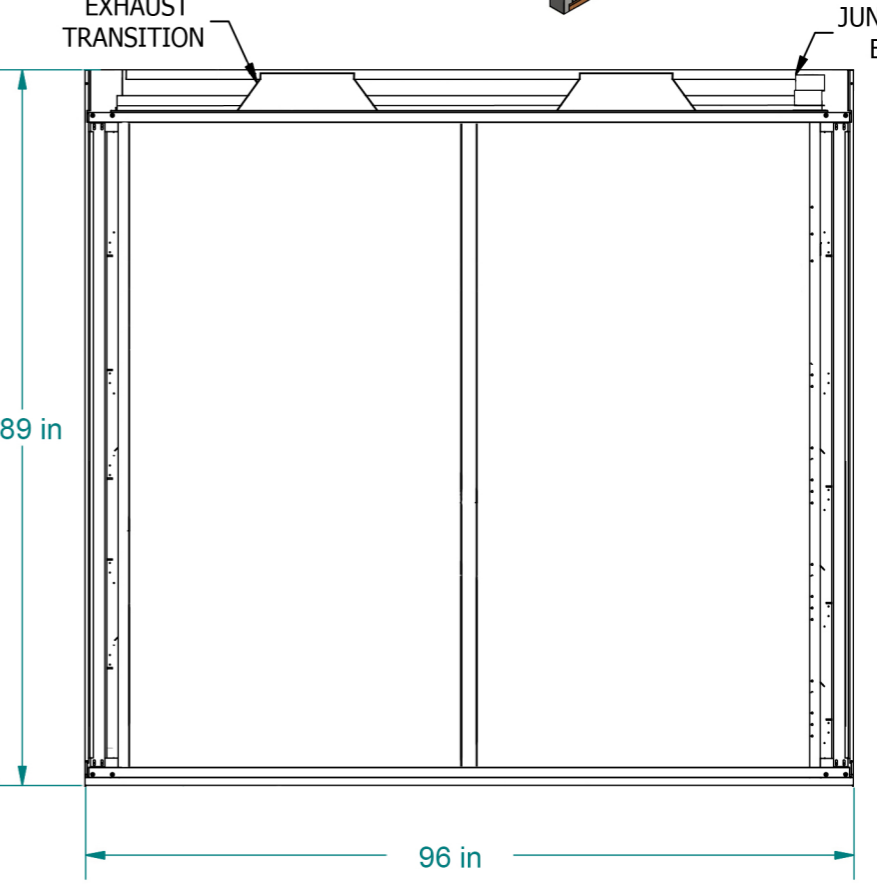

BACK VIEW SASH CLOSED

8' x 6' WALK-IN HOOD

FA FISHER AMERICAN CLASSIFIED UL

(815)-670-6400